



TM

ARCADE OPERATIONS MANUAL

WARNING

Be sure to read this Operation Manual before using your machine to ensure safe operation.



CHUCKIE CHEESE'S

© 2011 Bob's Space Racers® Incorporated

427 15th Street, Daytona Beach, Florida 32117

Tel: (386) 677-0761 Fax: (386) 677-0794

Table of Contents (for online viewers press "Ctrl+Home" at anytime to return to this page)

MODEL VIEW	2	Play zone (Operation Zone):.....	7	Main Board:	17
SPECIFICATIONS	3	Locations to avoid:.....	7	Glasses, Decorations:.....	18
Rated power supply:.....	3	Game Leveling:	8	Light Box Assembly:	18
Power consumption:.....	3	Connecting the power cord.....	9	Pump Assembly:	20
Dimensions:	3	INSTRUCTION FOR PLAY	10	Seat Assembly:	21
Weight:	3	PROGRAMMING CONSOLE .	11	Water Gun Assembly:.....	21
INTRODUCTION	4	Option Settings	12	Coin Door Assembly:	23
Overview:	4	MAINTENANCE AND		Fiberglass Kids Assembly:.....	24
To Maintain Safety:	4	INSPECTION	13	Cabinet Assembly:	26
WARNING: (or) CAUTION:	4	Maintenance:	13	WARRANTY	28
NOTE (or) NOTICE:	4	Cleaning:	13	CALLING FOR SERVICE	29
IMPORTANT SAFETY		TROUBLESHOOTING	14		
INFORMATION:	5	General Troubleshooting:	15		
SET UP:	5	PARTS LIST	16		
PACKAGE CONTENTS	6	Cabinet Decals:	16		
INSTALLATION	7				

www.bobsspacracers.com

MAY 2011

MODEL VIEW

[Back to TOC](#)

Stinky Feet™ Arcade Game



SPECIFICATIONS

[Back to TOC](#)

Rated power supply:

110VAC ± 10%, 60 Hz ± 3 Hz.

(Note: Please refer to the label on the game for the actual voltage).

Power consumption:

660W

Dimensions:

105" L x 30" W x 78 1/4" H

Weight:

386 lbs

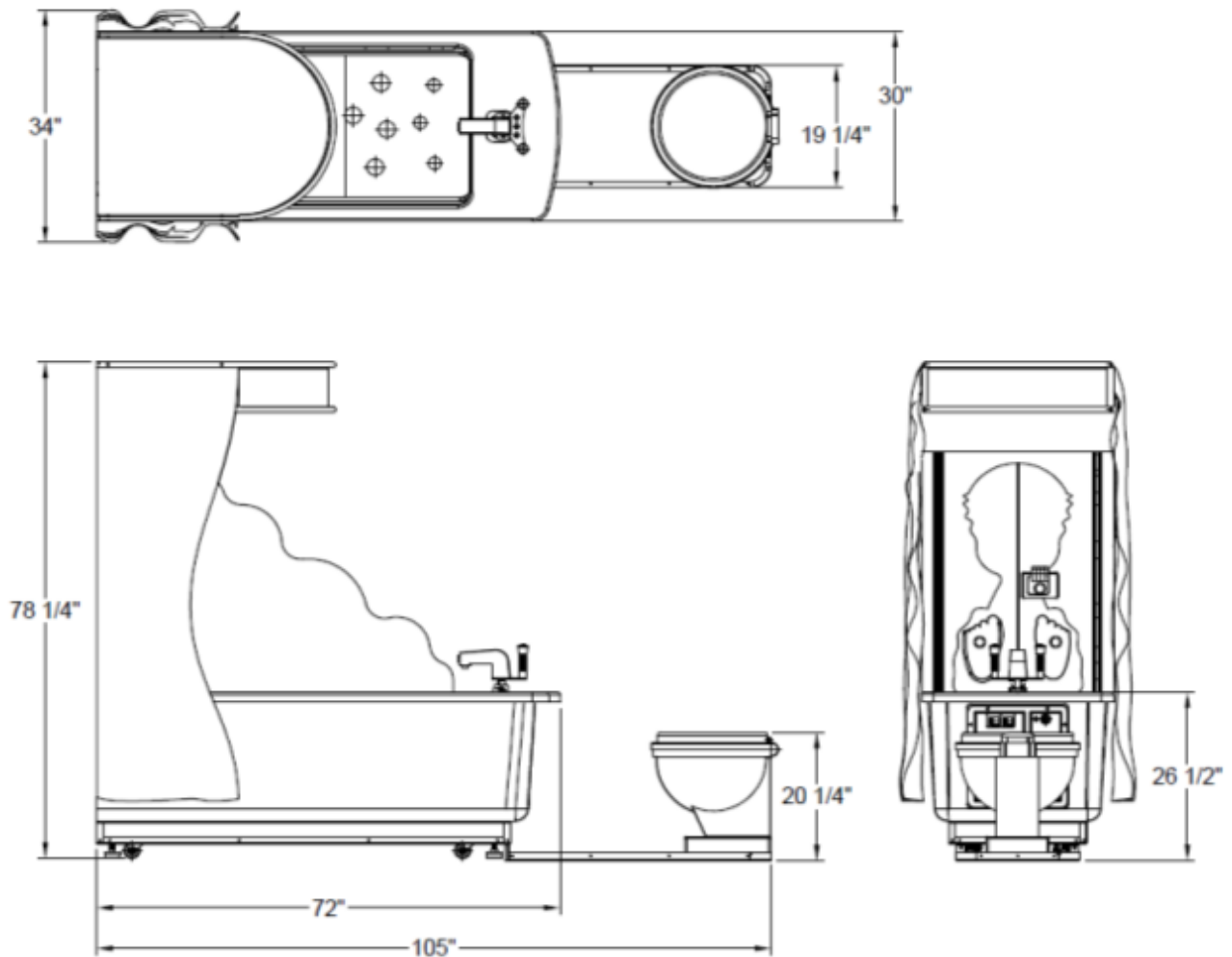

NOTE: Game parameters are subject to change without notice.

INTRODUCTION

[Back to TOC](#)

Overview:

Thank you for purchasing the new STINKY FEET™ from Bob's Space Racers®. Built on a long tradition of value, the new STINKY FEET™ retains all of the great game play you have come to expect of a game from BSR, and is specifically designed for today's Arcade environment. The new game uses technology specifically developed for this application.

This owner's Manual is intended to provide detailed descriptions together with all the necessary information covering the general operation of electronic assemblies, servicing control, spare parts, etc. pertaining to the game.

This manual is intended for the owner, personnel and managers in charge of operation of the product. Operate the product after carefully reading and sufficiently understanding the instructions. If the product fails to function satisfactorily, non-technical personnel should under no circumstances touch the internal system.

To Maintain Safety:

To ensure the safe usage of the product, be sure to read the following before using the product. The following instructions are intended for the users, operators and the personnel in charge of the operation of the product. After carefully reading and sufficiently understanding the warning display and cautions, handle the product appropriately. Be sure to keep this operation manual nearby the product or elsewhere convenient for referring to it when necessary.

Herein, explanations which require special attention are in sign of warning. Depending on the potentially hazardous degrees, the terms of NOTICE, WARNING, and CAUTION, etc. are used. Be sure to understand the content of the displays before reading the text.

WARNING: (or) CAUTION:

Disregarding this text could result in serious injury or damage to the machine.

WARNING: To Avoid
Risk of Shock, Refer Service
To Qualified Personnel.

WARNING:
This Part May Have A High Voltage
Present. Disconnect Power From
Equipment Before Servicing.

NOTE (or) NOTICE:

NOTE: ONLY QUALIFIED TECHNICAL PERSONNEL SHOULD WORK ON THIS GAME. FAILING TO COMPLY CAN CAUSE SEVERE INJURY.

IMPORTANT SAFETY INFORMATION:

[Back to TOC](#)

WARNING: Unplug the game from the AC wall receptacle when servicing this product. Failure to do so could result in serious injury to yourself or others.

Use only a GROUNDED AC receptacle. Failure to do so could result in improper operation or damage to the game and could void your warranty. If you are unsure that your AC receptacle is properly grounded, have a qualified electrician perform this check for you.

Always be sure power to the game is turned off when doing even routine maintenance. Otherwise, moving parts could activate unexpectedly causing injury.

This product is heavy, necessitated by the design. When moving this game, be sure you have adequate help. Use a suitable dolly or hand truck where practical. Use back support when needed.

SET UP:

[Back to TOC](#)

1. Be sure that the game is on a level surface. If the game is rocking on the floor adjust the legs to remove the rocking of the game.
2. Be sure to plug the game into the proper A.C. GROUNDED receptacle. Do not use long extension cords unless absolutely necessary and if so, be sure it is a heavy duty cord of at least 16 Ga. and no longer than 20 ft. Check the label on the back of the game to make sure the power requirements of the game match that of your location.
3. Turn the game on and check to be sure there are no unusual sounds and that everything appears to be working correctly.





PACKAGE CONTENTS

[Back to TOC](#)

Be sure to check that you have received all packages indicated below.

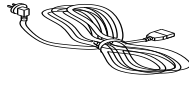
Game Unit

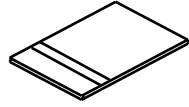
Accessories

No	Name	Regulation	Qty	Picture	Note
1	Power wire	10A/250V 1.8m	1		
2	Fuse	6.3 A/250V Φ 5-20MM	1		220V
3	Manual		1		
4	Key	X919	2		Front and back door
		X818	1		Coin box

INSTALLATION

[Back to TOC](#)

ATTENTION

- **For indoor use only!**

Check the parts list before installation. Verify that all parts that have been received and are in good condition.

Play zone (Operation Zone):

This machine requires space for playing the game. Be sure to leave enough space when installing the machine.

WARNING

- **Be sure to check the Electrical Specifications.** Ensure that this product is compatible with your location's power supply, voltage and frequency requirement. A plate describing Electrical Specifications is attached to the product. Non-compliance with the Electrical Specifications can cause a fire and electric shock.
- Putting many loads on one electrical outlet can cause generation of heat and a fire resulting from overload.

Locations to avoid:

NOTICE

The machine is designed for indoor use only. Never install this machine outdoors or in any of the following:

- Locations exposed to direct sunlight
- Locations subject to rain or water leakage.
- Unstable locations or locations subject to vibration.
- Dusty, hot, or damp locations.

Game Leveling:

[Back to TOC](#)

Install this machine on a flat surface. Adjust levelers to lift the legs and level game.

Make sure that the machine is level with the floor. If the machine is not level, the game may not play well.

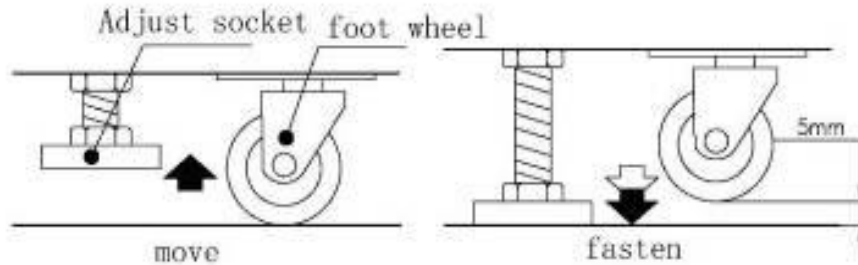

WARNING

- Disconnect game power before moving
- Make sure all wheels are intact. Replace any wheels that are damaged or broken before moving the game.
- When moving the game, DO NOT slide the game across the floor
- Ensure the game is level before connecting the power

Connecting the power cord

[Back to TOC](#)

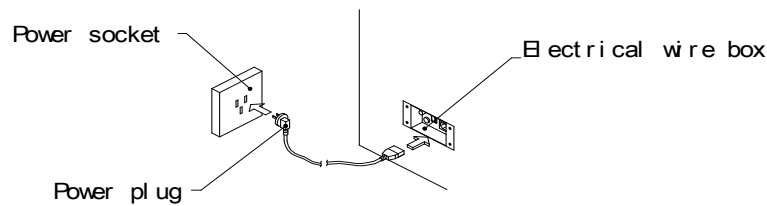

⚠ WARNING

- Do not put heavy items on power cord.

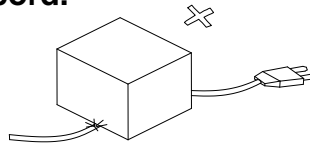

- Hold the power plug instead of the wire to draw the power cord out of the socket.

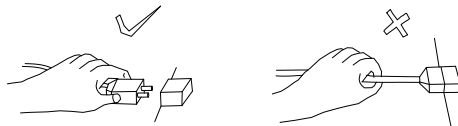

- Do not touch the power plug with wet hands.



- Do not draw or twist the cord or near a heat source.
- Do not place the cord where the player can easily trip over or come in contact with it.



- Operate this game with the correct power and fuse configuration. *(The machine's supply Voltage is 110VAC, please refer to the label on the machine, connect the actual supply voltage, if not, it can cause an electric shock or malfunction.)*

INSTRUCTION FOR PLAY

[Back to TOC](#)

1. Insert coin(s), the game starts.
2. When the game play starts, aim your gun at the lighted targets. The gun will shoot water automatically. All you have to do is aim.
3. Tickets will be awarded for each game play.
4. Bonus Tickets are awarded for beating the high score and the bonus score.

PROGRAMMING CONSOLE

[Back to TOC](#)

Programming Console
Located at the front of the game

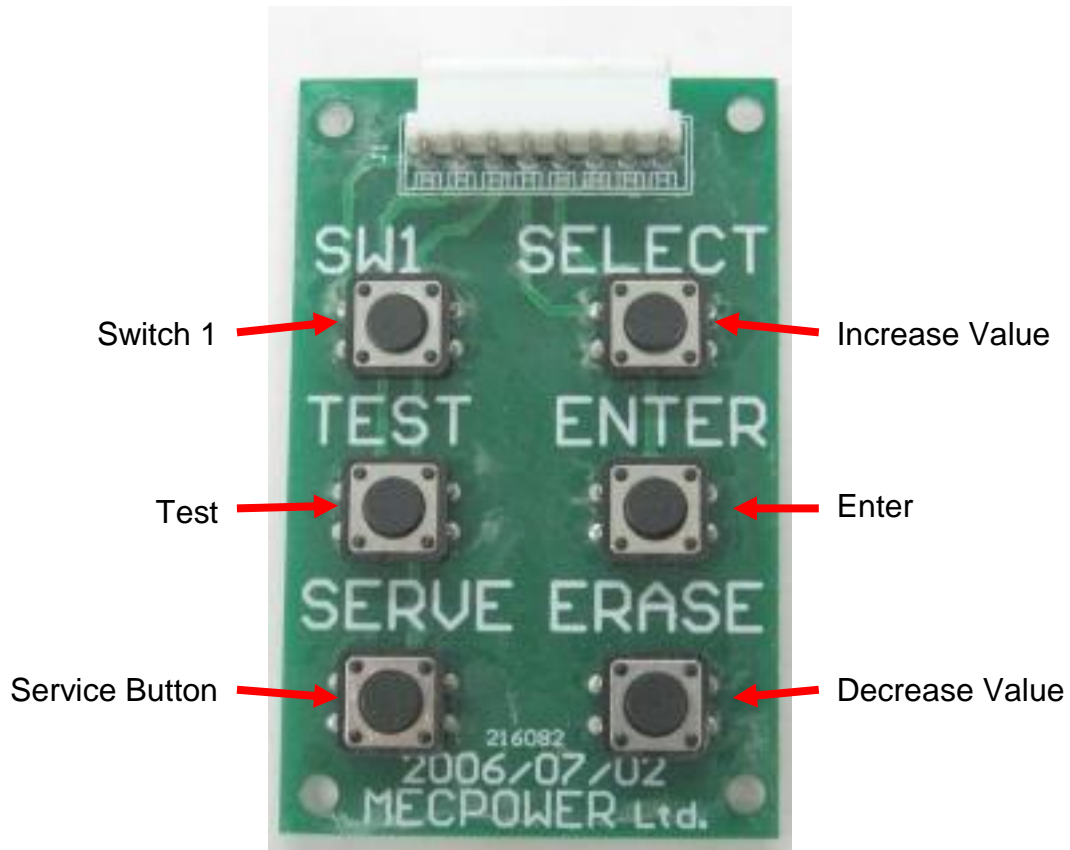

Press the **Service Button** to enter into programming mode as well as to select the parameters. Use the **Select Button** to increment the value of the parameter and **Erase Button** to decrement the value.

[Back to TOC](#)

Option Number	Description	Variation	CEC
1	Coins per play	(1 - 5)	1
2	High Score to Beat	(100 - 300)	130
3	Water Gun Demo Time (Gun fires for 15 secs)	(0 - 300)	0
4	Bonus Ticket Start Value	(0 - 100)	0
5	Bonus Ticket Adder	(0 - 5)	1
6	Max Bonus Payout	(0 - 500)	50
7	Score per Ticket	(0 - 60)	40
8	Game Time	(10 - 50)	20
9	Mercy Ticket	(0 - 7)	1
10	Points per hit	(1 - 15)	5
11	Demo Sound 15 secs of music every 45 seconds	(0 - 1)	0
12	Target Speed (10 is fastest 45 slowest)	(10 - 45)	45
13	Triangle or Random Pattern (1 - R, 0 - T)	(0 - 1)	0
14	Progressive Speed	(0 - 10)	0

MAINTENANCE AND INSPECTION

[Back to TOC](#)

Maintenance:

Due to the design of the machine, very little periodic maintenance is required.

Start the game and verify the correct operation before putting the game into everyday operations.

Clean the surface of the game as needed.

After about a month of game operation, check to be sure all parts are secure and in proper working order.

1. Remove power before servicing game.

To avoid a short circuit, the power must be removed before touching the inside of the game.

2. Choose the appropriate replacement parts.

Using the wrong parts could lead to malfunction or damage to the game and components.

3. Do not substitute or change equipment, without authorization.

Doing so could lead to a short circuit and machine malfunction, or fire.

4. Do not put containers of water, cups or soda cans on the machine. In addition, chemicals or heavy items should not be allowed around the game.

The spill could cause a short circuit. Falling items could injure people or destroy the machine.

Cleaning:

CLEANING - Clean the outer surfaces of the game with a commercial spray type cleaner. **DO NOT** however, use glass cleaner or commercial sprays on the marquee graphic panel. Use a good quality spray type furniture polish to keep the game looking good.

Vacuum the inside of the game occasionally to help keep the dust and ticket debris off of all the optical sensors.

TROUBLESHOOTING

[Back to TOC](#)

WARNING

For your safety, and to reduce risk of damage to your game read the Important Safety Information on page 7 before attempting any troubleshooting procedure.

TROUBLESHOOTING PHILOSOPHY

When troubleshooting any product, certain general guidelines should be followed.

1. Always check to be sure that your game is turned on. Be sure that all of the fuses in the game are functional and check to see that the AC voltage is in the proper operating range for your game.
2. Check to be sure that all of the game harnessing is plugged in properly and that all of the pins are firmly seated in the connectors. It is always possible that a harness can be damaged by rough shipping or moving.
3. Check game harnessing to be sure that none of the wires have become or are damaged. Using a handheld multi-meter, check continuity of the wires to make sure they are not broken.
4. Check for obvious damage to the P.C. Boards or electrical components.
5. If you have multiple games or multiple parts on a game, change or exchange the parts and see if the problem goes away or moves to another location. This way you can quickly eliminate certain parts as being the problem with the game.
6. When changing electronic or electrical components, ALWAYS disconnect power by unplugging the game.
7. Test power supplies for the specified voltages to the P.C. Boards and components as shown in the manual.

General Troubleshooting:[Back to TOC](#)

Symptom	Possible Problem	Solution
	POWER	POWER
Game will not score	Power not on switch Sensor output not correct Signal not getting to main board Signal gets to main board but board doesn't see it	Check wiring harness for 12 volts on switch Repair / Replace switch Repair / Replace harness Replace main board
Sound Problems -No sound -Low Sound -Intermittent Sound	Low Volume Faulty speaker harnessing Faulty speaker Faulty sound board or sound board harnessing Faulty Main P.C. Board	Check Volume Control and adjust as necessary Check connections and/or repair harnessing Check and/or replace speaker Check connections or Replace Sound Board Check and/or repair or replace Main PCB Board
Game does not take or add money correctly	Coin switch out of adjustment Coin mech dirty or improperly adjusted Faulty Coin switch Faulty coin switch harness or connector Game improperly programmed Faulty Main P.C. Board or component	Re-bend coin switch wire Clean and adjust mech as necessary Check and/or replace switch Check and/or repair harnessing Check programming options and adjust Repair and/or replace Main P.C. board
Ticket Dispenser not working properly, or no tickets being dispensed	No tickets in the game Tickets jammed in dispenser Ticket dispenser sensor blocked with debris Poor connection on the ticket dispenser Game improperly programmed Faulty ticket dispenser Faulty ticket dispenser harnessing Faulty Main P.C. Board	Refill ticket dispenser Clear ticket jam Clean off sensor Check and/or replace connectors Check ticket programming options Replace dispenser Check and/or repair harnessing Replace or repair Main P.C. Board
Game will not start.	Game power off Electrical Power Switch Open Main fuse blown Power Supply problem or failure Faulty P.C. board or component	Check on/off switch and power cord Close Electrical Power Switch Check and/or replace fuse as necessary Check Power Supply output and connections Repair and/or replace main P.C. board
Game stops or is stopped with nothing displayed	The power connector is disconnected. Possible faulty connection or short circuit.	Reconnect the connector securely. Check all circuitry for faulty connections or short circuits.

NOTE: CONTACT YOUR DISTRIBUTOR IF NONE OF THE CASES LISTED IN THIS MANUAL APPLIES TO THE PROBLEM, OR IF THE ACTION LISTED DOES NOT APPEAR TO RESOLVE THE PROBLEM.

PARTS LIST[Back to TOC](#)



Reference Number	Part Number	Description	Photo
<i>Cabinet Decals:</i>			
SF100-001-000	TBD	Decal	
SF100-001-001	TBD	Decal	
SF100-001-002	TBD	Decal	
SF100-001-003	TBD	Decal	
SF100-001-004	TBD	Decal	
SF100-001-005	TBD	Decal	
SF100-001-006	TBD	Decal	
SF100-001-007	TBD	Decal	
SF100-001-008	TBD	Decal	

SF100-001-009	TBD	Decal	
SF100-001-010	TBD	Decal	
SF100-001-011	TBD	Decal	
SF100-001-012	TBD	Decal	
SF100-001-013	TBD	Decal	
SF100-001-014	TBD	Decal	
Main Board:			
SF100-001-015	TBD	PCB Base Board	Photo Coming Soon
SF100-001-016	TBD	Iron Port	Photo Coming Soon
SF100-001-017	E0801000	Solid State Relay 25A	
SF100-001-018	E0801002	Sound Board	
SF100-001-019	E0801001	Main Board	

SF100-001-020	E0801003	Main Board Chip Set	
<i>Glasses, Decorations:</i>			
SF100-001-021	M0801001-LEFT	Left Curtain	
SF100-001-022	M0801001-RIGHT	Right Curtain	
SF100-001-023	M0801003	Glasses	
<i>Light Box Assembly:</i>			
SF100-001-024	TBD	6 Pin Connector	Photo Coming Soon
SF100-001-025	TBD	PCB Port	Photo Coming Soon
SF100-001-026	E0801004	I/O Board	
SF100-001-027	TBD	Fan	
SF100-001-028	TBD	Fan Mesh	
SF100-001-029	TBD	Back Door 1	Photo Coming Soon

SF100-001-030	E0801005	Display Board (3-Digit)	
SF100-001-031	E0801006	Power Supply (5V6A / 12V8A)	
SF100-001-032	E0801007	Power Supply (+12 V / - 12 V)	
SF100-001-033	TBD	Holder for Power Supply	Photo Coming Soon
SF100-001-034	E0801008	LED Light Board 1	
SF100-001-035	E0801009	LED Spot Light	
SF100-001-036	M0801004	Speaker 4"	Photo Coming Soon
SF100-001-037	M0801005	Decoration Pole	Photo Coming Soon
SF100-001-038	M0801006	Decoration Board	
SF100-001-039	E0801010	Speaker Chase Light	
SF100-001-040	M0801008	Speaker Acrylic	Photo Coming Soon
SF100-001-041	M0801009	Speaker Mesh	

SF100-001-042	W0801007	LED Light Bracket	Photo Coming Soon
SF100-001-043	P0010200	Shower Head	
SF100-001-044	P0801017	PVC Pipe	Photo Coming Soon
<i>Pump Assembly:</i>			
SF100-001-045	P0801005	Solenoid Valve 1	
SF100-001-046	P0801006	Solenoid Valve 2	
SF100-001-047	P0801007	Water Pipe 1	Photo Coming Soon
SF100-001-048	P0801008	Connector 1	Photo Coming Soon
SF100-001-049	P0801009	Water Filter	
SF100-001-050	P0801010	Water Pipe 2	Photo Coming Soon
SF100-001-051	P0801011	Water Tap	
SF100-001-052	P0801012	Water Pipe 3	Photo Coming Soon

SF100-001-053	P0801013	Connector 2	Photo Coming Soon
SF100-001-054	P0801014	Pump	Photo Coming Soon
SF100-001-055	P0801015	Conn 1 For Big Water Pipe	Photo Coming Soon
SF100-001-056	P0801015	Big Water Pipe	Photo Coming Soon
<i>Seat Assembly:</i>			
SF100-001-057	M0005473	Seat	
SF100-001-058	M0801010	Pedal Board Acrylic	Photo Coming Soon
SF100-001-059	M0801011	Pedal Light Board	Photo Coming Soon
SF100-001-060	TBD	Pedal Chassis	Photo Coming Soon
<i>Water Gun Assembly:</i>			
SF100-001-061	W0801001	Handle Cover	
SF100-001-062	W0801002	Handle	
SF100-001-063	W0801003	Gun Cover	

SF100-001-064	W0801004	Gun Boot	
SF100-001-065	TBD	Connecting Pole	Photo Coming Soon
SF100-001-066	TBD	Shaft Sleeve	Photo Coming Soon
SF100-001-067	TBD	Shaft Bracket 1	Photo Coming Soon
SF100-001-068	TBD	Bracket Connecting Piece 1	Photo Coming Soon
SF100-001-069	TBD	Pole 1	Photo Coming Soon
SF100-001-070	TBD	Pole Casing 1	Photo Coming Soon
SF100-001-071	TBD	Bearing 1	
SF100-001-072	TBD	Shaft Frame	
SF100-001-073	TBD	Gun Chassis	Photo Coming Soon
SF100-001-074	W0801005	Gun Base	Photo Coming Soon
SF100-001-075	TBD	Shaft Frame 2	Photo Coming Soon

SF100-001-076	TBD	Pole 2	Photo Coming Soon
SF100-001-077	TBD	Pole 3	Photo Coming Soon
SF100-001-078	TBD	Shaft Frame 3	Photo Coming Soon
SF100-001-079	TBD	Shaft Bracket 2	Photo Coming Soon
SF100-001-080	TBD	Bracket Connecting Piece 2	Photo Coming Soon
SF100-001-081	TBD	Gun Cover Connecting Piece	Photo Coming Soon
SF100-001-082	W0801006	Gun Head	
SF100-001-083	TBD	Water Tubing	
<i>Coin Door Assembly:</i>			
SF100-001-084	M0801012	Ticket Box	Photo Coming Soon
SF100-001-085	M0801013	Meter	Photo Coming Soon
SF100-001-086	M0801014	Ticket Dispenser	Photo Coming Soon

SF100-001-087	M0801015	Programming Board	
SF100-001-088	M0801016	Coin Door Assembly	Photo Coming Soon
SF100-001-089	M0801017	No Ticket Indicator	Photo Coming Soon
SF100-001-090	M0801018	Lock 1285	Photo Coming Soon
SF100-001-091	M0801019	Coin Mech	
SF100-001-092	M0801020	Lock 1396	Photo Coming Soon
<i>Fiberglass Kids Assembly:</i>			
SF100-001-093	M0801000	Fiberglass Figure	Photo Coming Soon
SF100-001-094	M0801021	Acrylic Box 1 (Soap)	
SF100-001-095	E0801012	Chase Light Board (Soap)	Photo Coming Soon
SF100-001-096	M0801022	Acrylic Box 2 (Soap)	
SF100-001-097	E0801013	Scoring Sensor Chip 1	

SF100-001-098	M0801023	Acrylic Cover (Soap)	Photo Coming Soon
SF100-001-099	M0801024	Acrylic Box 1 (Left Door)	Photo Coming Soon
SF100-001-100	M0801025	Acrylic Box 1 (Right Door)	Photo Coming Soon
SF100-001-101	E0801014	Scoring Sensor Chip	
SF100-001-102	M0801026	Acrylic Cover (Left Foot)	
SF100-001-103	M0801027	Acrylic Cover (Right Foot)	
SF100-001-104	M0801028	Acrylic Box 2 (Left Foot)	
SF100-001-105	M0801029	Acrylic Box 2 (Right Foot)	
SF100-001-106	E0801015	Chase Light Board (Left Foot)	Photo Coming Soon
SF100-001-107	E0801016	Chase Light Board (Right Foot)	Photo Coming Soon
SF100-001-108	E0801017	Switch	Photo Coming Soon

Cabinet Assembly:			
SF100-001-109	E0801018	Micro-Switch	Photo Coming Soon
SF100-001-110	E0801019	Medium Button with Light	Photo Coming Soon
SF100-001-111	M0801030	Water Drain Pan Acrylic Board	Photo Coming Soon
SF100-001-112	E0801020	Chase Light Strip	Photo Coming Soon
SF100-001-113	P0801018	Outlet	Photo Coming Soon
SF100-001-114	P0801020	Outlet Assembly	Photo Coming Soon
SF100-001-115	M0801031	Water Drain Pan	Photo Coming Soon
SF100-001-116	M0801032	Fiberglass Cabinet	Photo Coming Soon
SF100-001-117	P0801021	Filter Holder	Photo Coming Soon
SF100-001-118	E0801021	Switch Box	Photo Coming Soon
SF100-001-119	P0801022	Power Filter	Photo Coming Soon

SF100-001-120	M0801033	Cabinet Chassis	Photo Coming Soon
SF100-001-121	TBD	Wheel	Photo Coming Soon
SF100-001-122	TBD	Foundation	Photo Coming Soon
SF100-001-123	E0801011	Medium Button with Light	Photo Coming Soon

WARRANTY

[Back to TOC](#)

BOB'S SPACE RACERS INC. 90 DAY COIN-OPERATED GAME WARRANTY

1. INCLUDED IN THIS WARRANTY Bob's Space Racers®, Inc. warrants to the original purchaser only that the equipment that is the subject of this sale conforms to its specifications, and is free from defects under normal service for a 90 day period from the original date of deliver. This warranty does not include any damages resulting from occurrences listed in paragraph 2 below. This warranty is not transferable under any circumstance. Any claims under this warranty must be received in writing by Bob's Space Racers®, Inc. within 120 days from date of delivery. Within a reasonable time of such written notification Bob's Space Racers®, Inc. will replace or repair any defective component of the equipment or part thereof which fails for reasons other than normal service, use, or wear. Bob's Space Racers®, Inc. reserves the right to request dated proof of purchase by the end user (original purchaser) at any time. Light bulbs are specifically excluded from this warranty and shall be the sole responsibility of the purchaser. Bob's Space Racers®, Inc., within its sole discretion, makes the final determination as to whether to repair or replace any component and whether any such repair or replacement shall be performed where the equipment is located or at its home facility in Volusia County, Florida, or another facility of its sole choice. Any and all freight charges for the purposes of repair or replacement shall be paid by the original purchaser. All defective parts shall be returned to Bob's Space Racers®, Inc. if requested. Bob's Space Racers®, Inc. does not warrant that the equipment will meet any original purchaser's specific requirements or that the operation of the equipment will be uninterrupted. These remedies are the original purchaser's exclusive remedies for breach of warranty.

2. EXCLUDED BY THIS WARRANTY Bob's Space Racers®, Inc. does not warrant (a) any product, components or parts not manufactured by Bob's Space Racers®, Inc.; (b) damages caused by use of the equipment for purposes other than those for which it was designed; (c) defects caused by failure to provide a suitable installation environment for the equipment; (d) damage caused by unauthorized attachments, modification, or service; (e) damage caused by normal wear and tear or improper power supply; (f) damage caused by accident or disaster such as fires, flood, lightning, and wind; or (g) any other abuse or misuse of the equipment.

3. EXCLUSIVE WARRANTY. THE FORGOING WARRANTY IS EXCLUSIVE AND IN LIEU OF ALL OTHER WARRANTIES OR REMEDIES, WHETHER WRITTEN, ORAL OR IMPLIED. THERE ARE NO WARRANTIES WHICH EXTEND BEYOND THE DESCRIPTION ON THE FACE HEREOF. ANY AND ALL IMPLIED WARRANTIES OF MERCHANTABILITY, FITNESS FOR A PARTICULAR PURPOSE, COURSE OF DEALING OR USAGE OF TRADE ARE HEREBY EXPRESSLY DISCLAIMED AND EXCLUDED.

4. REMEDIES LIMITED. UNDER NO CIRCUMSTANCES, EXCEPT TO THE EXTENT PROHIBITED BY APPLICABLE LAW, SHALL BOB'S SPACE RACERS®, INC. BE LIABLE FOR ANY LOSS OR DAMAGE, DIRECT OR INDIRECT, SPECIAL INCIDENTAL OR CONSEQUENTIAL ARISING OUT OF THE USE OR INABILITY TO USE THIS EQUIPMENT INCLUDING BUT NOT LIMITED TO ANY CLAIM FOR LOSS OR PROFITS, LOSS OF SAVINGS OR REVENUE, LOSS OF USE OF THE EQUIPMENT, OR ANY ASSOCIATED EQUIPMENT, FACILITIES OR SERVICE, DOWNTIME, THE CLAIMS OR COSTS OF THIRD PARTIES INCLUDING CUSTOMERS AND INJURY TO PROPERTY. Some states do not allow limitations on how long an implied warranty lasts or the exclusion or limitation of incidental or consequential damages, so the above limitations or exclusion may not apply to you. This warranty gives you specific legal rights, and you may also have other rights which vary from state to state.

5. NO OTHER WARRANTIES. Unless modified in writing and signed by both parties, this agreement is understood to be the complete and exclusive agreement between the parties, superseding all prior agreements, oral or written, and all other communications between the parties relating to the subject matter of this agreement. No employee or representative of Bob's Space Racers®, Inc. or any other party is authorized to make any other warranty or to assume any other liability in connection with the sale of its equipment.

6. TIME LIMIT FOR CLAIMS. Any claim for breach of warranty or claims under this warranty must be received in writing by Bob's Space Racers®, Inc. within 120 days following delivery of the equipment.

7. FUTURE CHANGES. Bob's Space Racers®, Inc. reserves the right to reserve, change or modify the construction and design of its equipment or any component part or parts thereof without incurring the obligations to make such changes or modifications in present equipment.

8. ALLOCATION OF RISKS. This agreement allocates the risks of equipment failure between Bob's Space Racers®, Inc. and the original purchaser. This allocation is recognized by both parties and is reflected in the price of the goods. THE PURCHASER ACKNOWLEDGES THAT HE HAS READ THIS AGREEMENT, UNDERSTANDS IT, AND IS BOUND BY ITS TERMS.

9. TO OBTAIN WARRANTY SERVICE. The original purchaser must, at his/her own expense, bring or ship the equipment to an authorized location for service. Additionally, the original purchaser must pay all freight, shipping or transportation charges for the return of the equipment from Bob's Space Racers®, Inc. to the original purchaser. Telephone or write:

Bob's Space Racers®, Inc.
427 15th Street
Daytona Beach, FL 32117
Telephone number: 386/677-0761
FAX: 386/677-0794

CALLING FOR SERVICE

[Back to TOC](#)

1. When calling for service, please check the service manual first. Many times the answer to your problem has been addressed in this documentation.
2. Please make sure you have the serial number of the game ready when you call.
3. If this is a repeat call, please tell the service technician that you have made a previous call regarding this problem. This way we will be able to retrieve the history on your game allowing us to serve you better and save you time.
4. Please retain proof of purchase for your product. This might be requested for warranty repairs.
5. Please call from the game if possible since we might need you to check certain things on the game while we are on the telephone with you.

IF YOU HAVE ANY QUESTIONS OR COMMENTS, PLEASE CALL OUR SERVICE
DEPARTMENT AT

(386) 677-0761

(MONDAY – FRIDAY, 8:30AM – 5:00PM EST, EXCLUDING HOLIDAYS)

(or)

EMAIL QUESTIONS TO: Tech@BobsSpaceRacers.com

(or)

**VISIT THE “CUSTOMER SUPPORT” SECTION ON OUR WEBSITE:
WWW.BOBSSPACERACERS.COM**